

NH-5013PH



MAGNETICALLY DRIVEN, MULTI-STAGE CENTRIFUGAL



- ☑ Up to 540l/min flow
- ☑ Up to 33m head
- ☑ Available with Threaded or Flange connections
- ☑ Easy Maintenance
- ☑ Long operating lifespan

SPECIFICATION

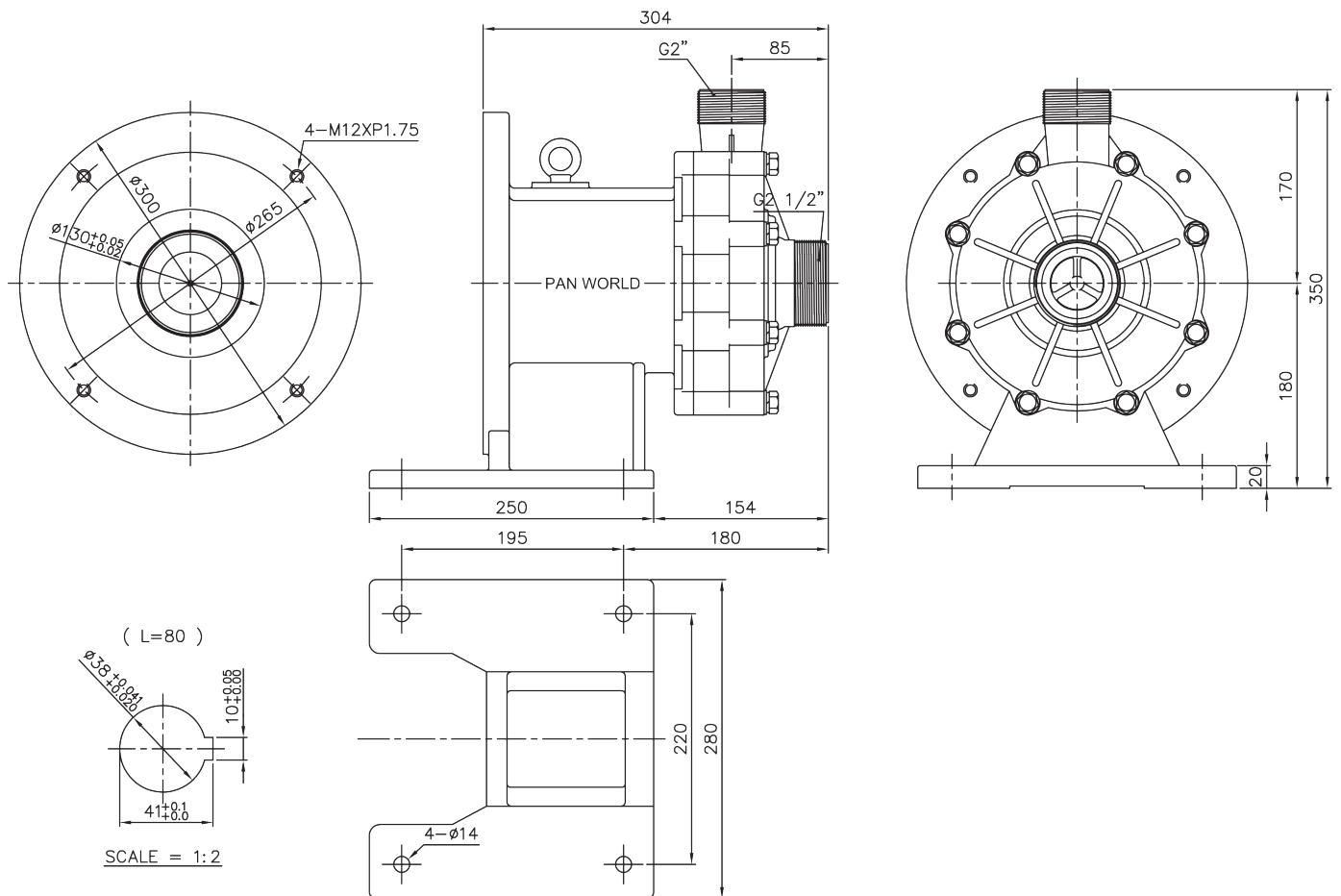

THREADED VARIANT SHOWN

FEATURES

Temp:	Max 70°C
Pressure:	4.9 Bar (System)
Connections:	BSP Threaded Flanged

WETTED MATERIALS

Front Cover:	PPS
O Ring:	Viton
Impeller:	PPS
Shaft:	Ceramic
Thrust Washer:	Ceramic
Rear Housing:	PPS



March May Ltd, Howard Road, Eaton Socon, St. Neots, Cambridgeshire, PE19 8NZ, UK

Tel: +44 (0) 1480 214444 Fax: +44 (0) 1480 405336 E-mail: sales@marchmay.co.uk Website: www.marchmay.co.uk

NH-5013PH



MAGNETICALLY DRIVEN, MULTI-STAGE CENTRIFUGAL

PERFORMANCE

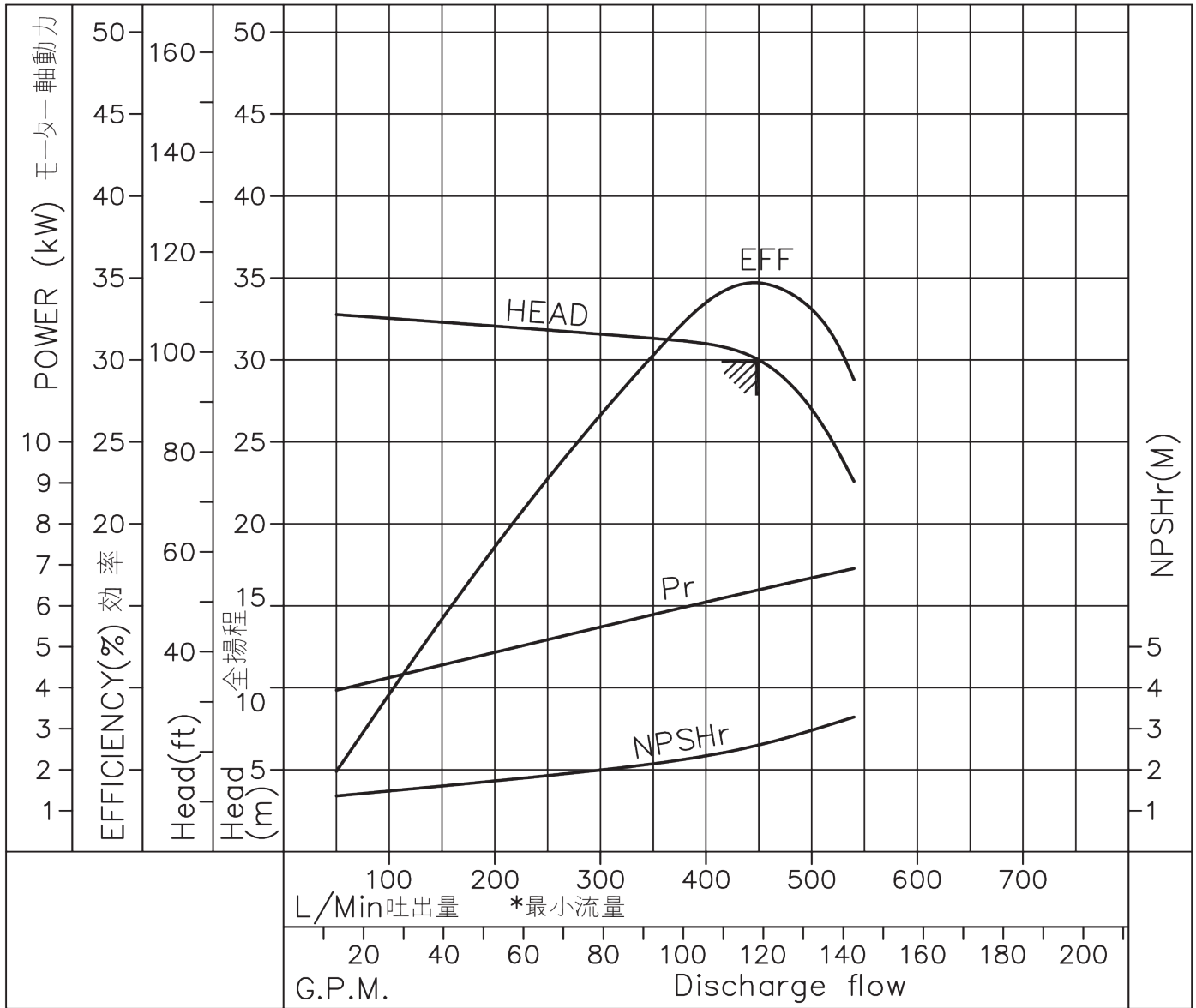

IMPELLER SIZE
145mm
S.G: 1.0



March May Ltd, Howard Road, Eaton Socon, St. Neots, Cambridgeshire, PE19 8NZ, UK

Tel: +44 (0) 1480 214444 Fax: +44 (0) 1480 405336 E-mail: sales@marchmay.co.uk Website: www.marchmay.co.uk