

# NH-5012PH



MAGNETICALLY DRIVEN, MULTI-STAGE CENTRIFUGAL



- ☑ Up to 540l/min flow
- ☑ Up to 24m head
- ☑ Available with Threaded or Flange connections
- ☑ Easy Maintenance
- ☑ Long operating lifespan

## SPECIFICATION

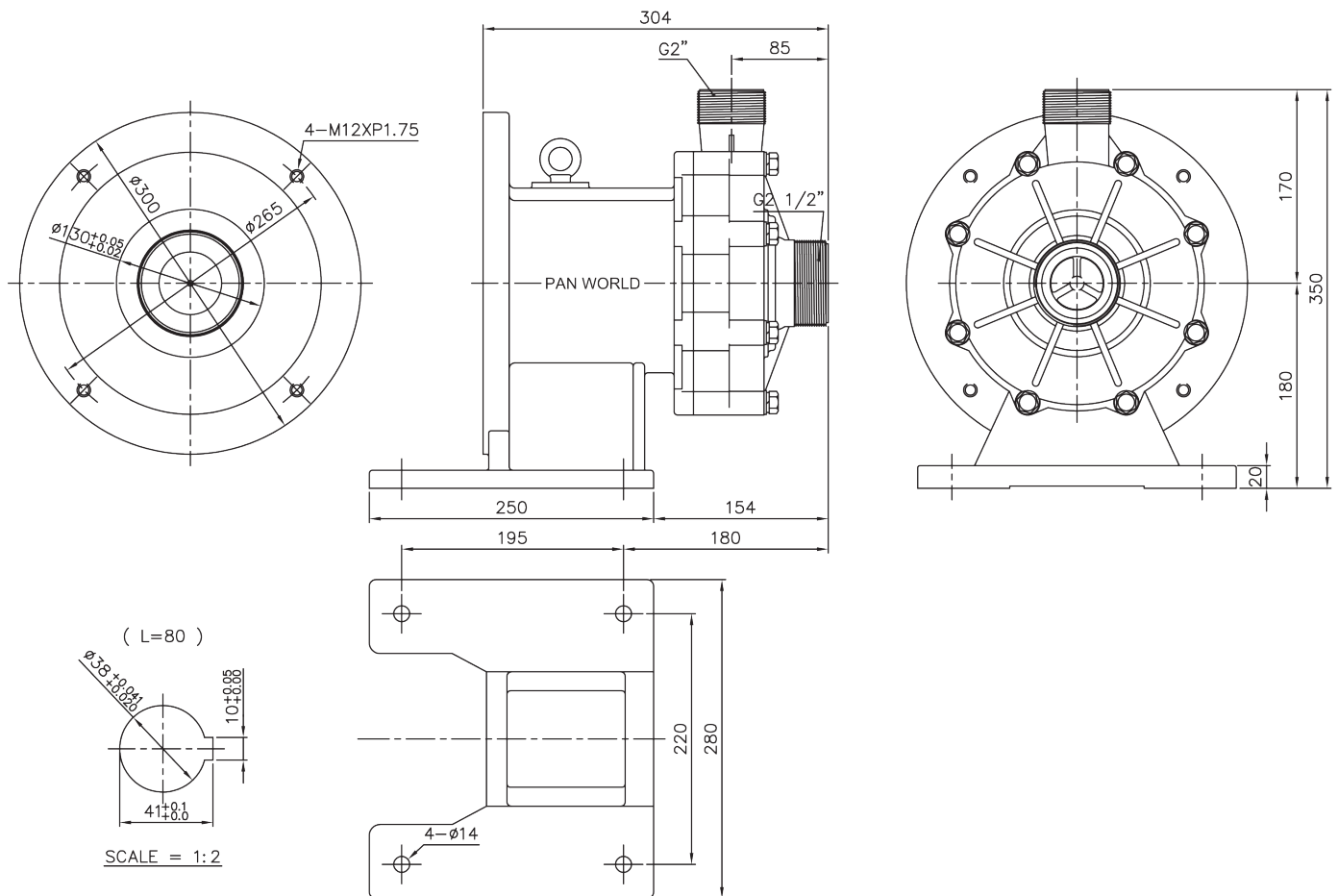

THREADED VARIANT SHOWN

## FEATURES

Temp:	Max 70°C
Pressure:	3.5 Bar (System)
Connections:	BSP Threaded Flanged

## WETTED MATERIALS

Front Cover:	PPS
O Ring:	Viton
Impeller:	PPS
Shaft:	Ceramic
Thrust Washer:	Ceramic
Rear Housing:	PPS



March May Ltd, Howard Road, Eaton Socon, St. Neots, Cambridgeshire, PE19 8NZ, UK

Tel: +44 (0) 1480 214444 Fax: +44 (0) 1480 405336 E-mail: sales@marchmay.co.uk Website: www.marchmay.co.uk

# NH-5012PH



MAGNETICALLY DRIVEN, MULTI-STAGE CENTRIFUGAL

## PERFORMANCE

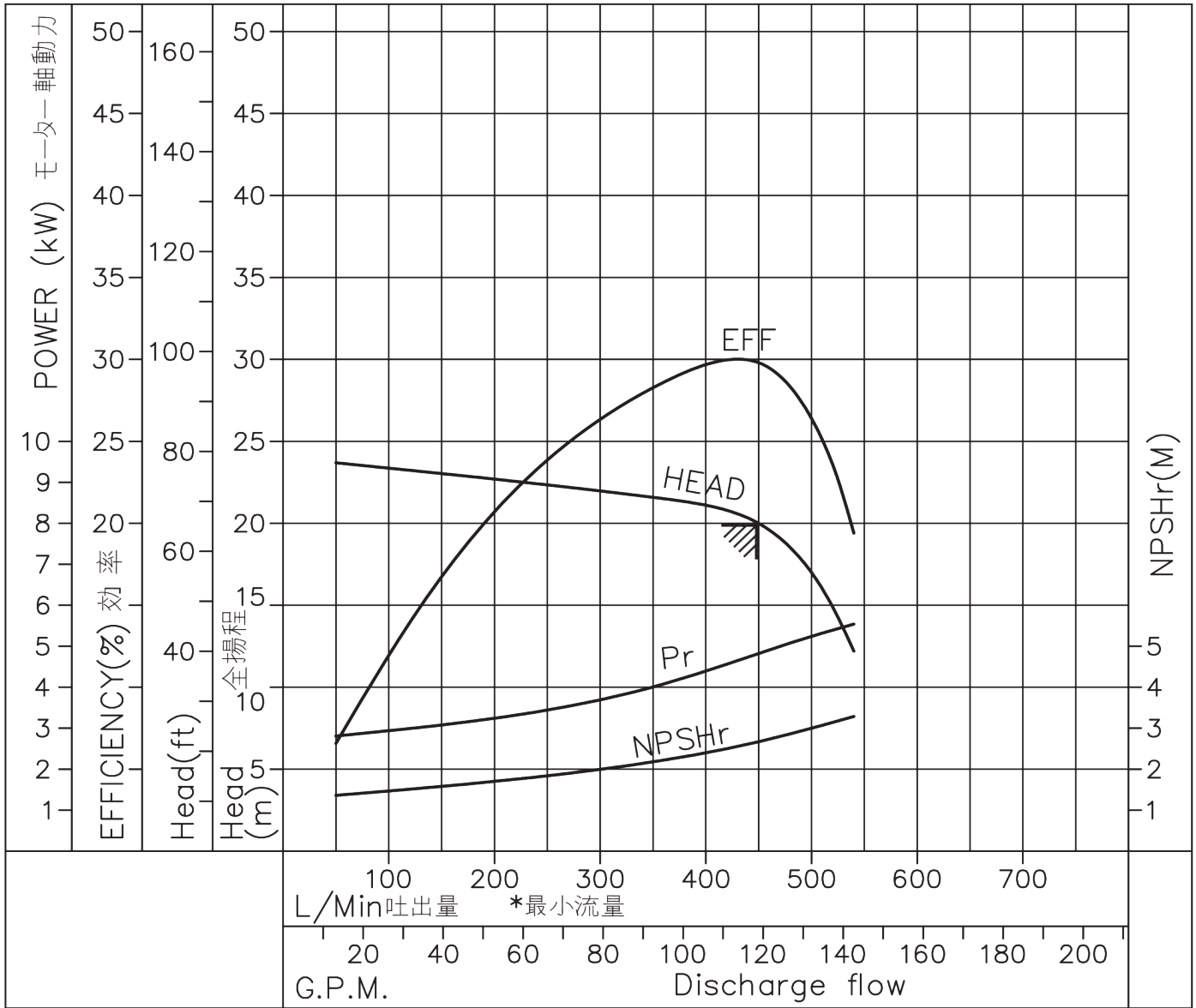

IMPELLER SIZE  
145mm  
S.G: 1.0



March May Ltd, Howard Road, Eaton Socon, St. Neots, Cambridgeshire, PE19 8NZ, UK

Tel: +44 (0) 1480 214444 Fax: +44 (0) 1480 405336 E-mail: sales@marchmay.co.uk Website: www.marchmay.co.uk