

NH-4013PH



MAGNETICALLY DRIVEN, MULTI-STAGE CENTRIFUGAL



- ☑ Up to 360l/min flow
- ☑ Up to 34m head
- ☑ Available with Threaded or Flange connections
- ☑ Easy Maintenance
- ☑ Long operating lifespan

SPECIFICATION

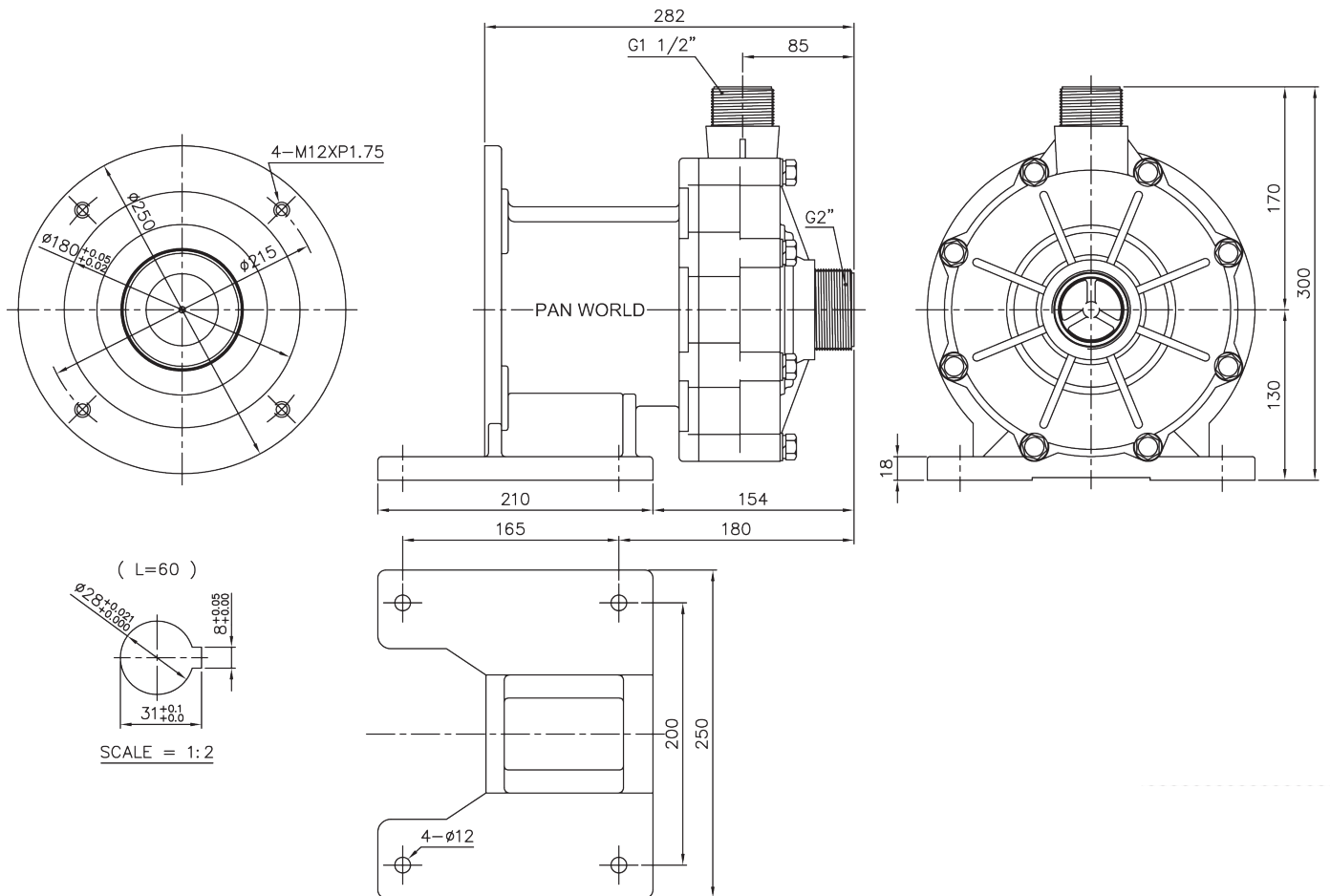

THREADED VARIANT SHOWN

FEATURES

Temp: Max 70°C
Pressure: 5 Bar (System)
Connections: BSP Threaded
Flanged

WETTED MATERIALS

Front Cover: PPS
O Ring: Viton
Impeller: PPS
Shaft: Ceramic
Thrust Washer: Ceramic
Rear Housing: PPS



March May Ltd, Howard Road, Eaton Socon, St. Neots, Cambridgeshire, PE19 8NZ, UK

Tel: +44 (0) 1480 214444 Fax: +44 (0) 1480 405336 E-mail: sales@marchmay.co.uk Website: www.marchmay.co.uk

NH-4013PH



MAGNETICALLY DRIVEN, MULTI-STAGE CENTRIFUGAL

PERFORMANCE

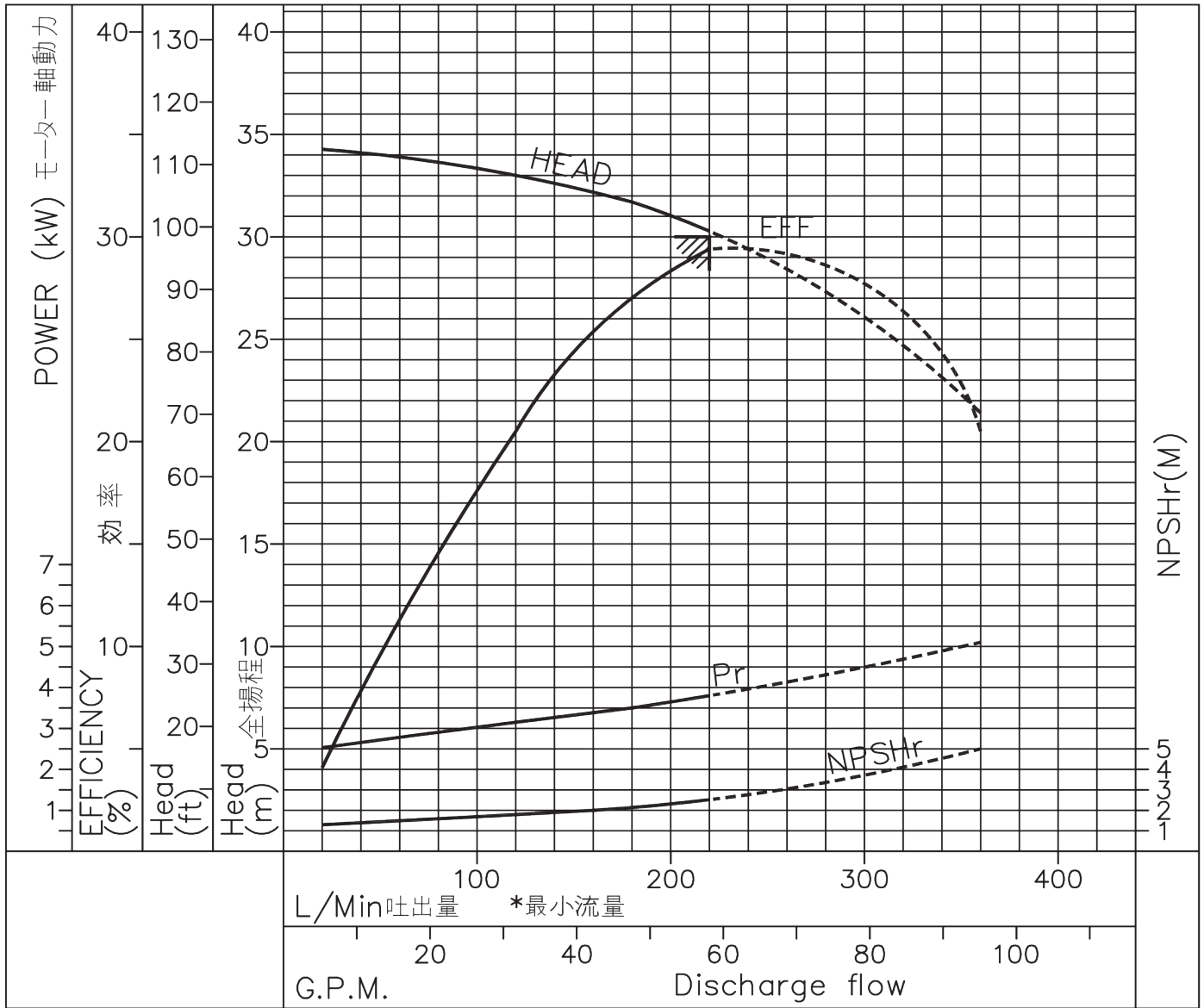

IMPELLER SIZE
170mm
S.G: 1.0



March May Ltd, Howard Road, Eaton Socon, St. Neots, Cambridgeshire, PE19 8NZ, UK

Tel: +44 (0) 1480 214444 Fax: +44 (0) 1480 405336 E-mail: sales@marchmay.co.uk Website: www.marchmay.co.uk