

# NH-3024PH

MAGNETICALLY DRIVEN, MULTI-STAGE CENTRIFUGAL



- ☑ Up to 180l/min flow
- ☑ Up to 51m head
- ☑ Available with Threaded or Flange connections
- ☑ Easy Maintenance
- ☑ Long operating lifespan

## SPECIFICATION

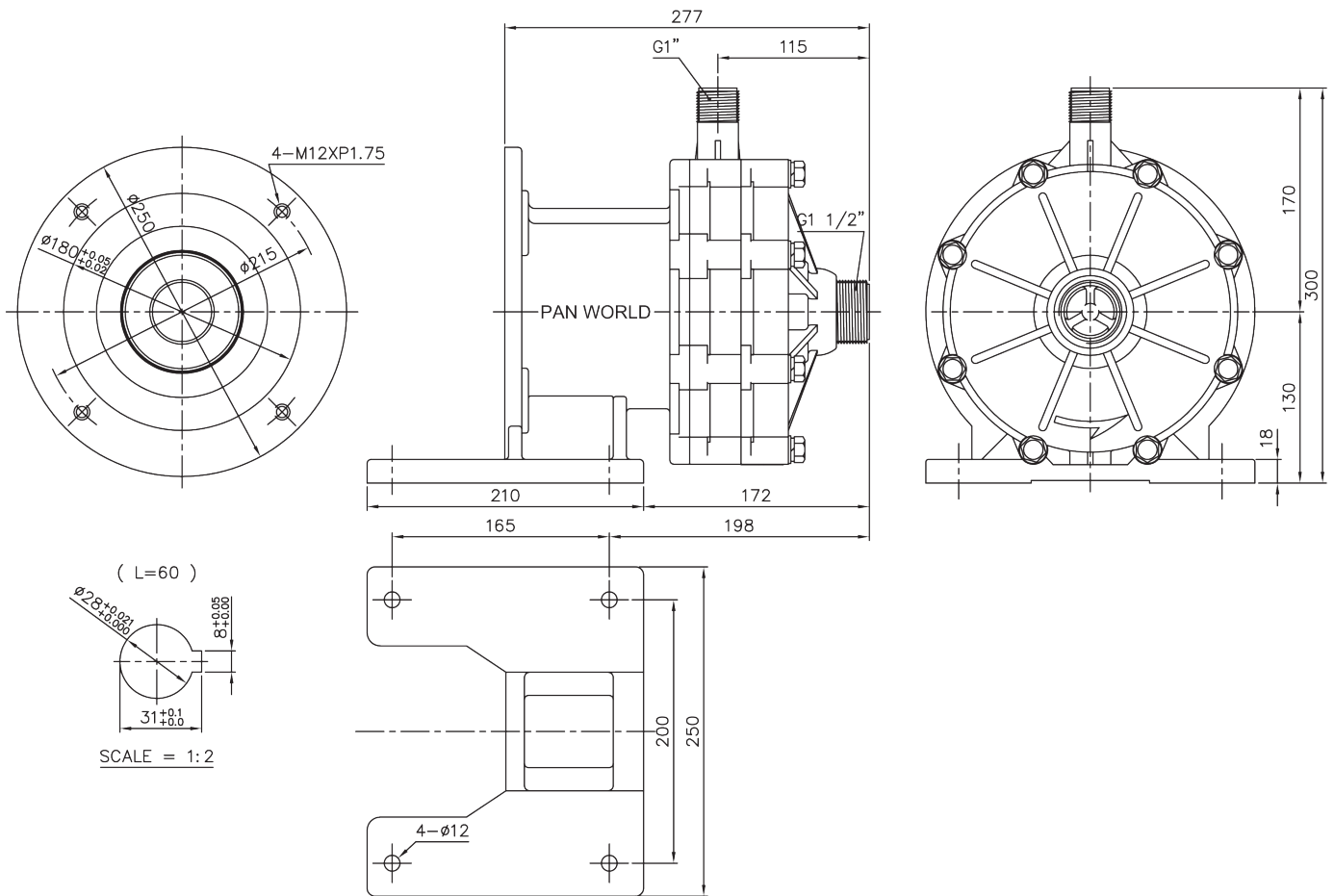

THREADED VARIANT SHOWN

## FEATURES

Temp: Max 70°C  
Pressure: 7.5 Bar (System)  
Connections: BSP Threaded  
Flanged

## WETTED MATERIALS

Front Cover: PPS  
O Ring: Viton  
Impeller: PPS  
Shaft: Ceramic  
Thrust Washer: Ceramic  
Rear Housing: PPS



March May Ltd, Howard Road, Eaton Socon, St. Neots, Cambridgeshire, PE19 8NZ, UK

Tel: +44 (0) 1480 214444 Fax: +44 (0) 1480 405336 E-mail: sales@marchmay.co.uk Website: www.marchmay.co.uk

# NH-3024PH



MAGNETICALLY DRIVEN, MULTI-STAGE CENTRIFUGAL

## PERFORMANCE

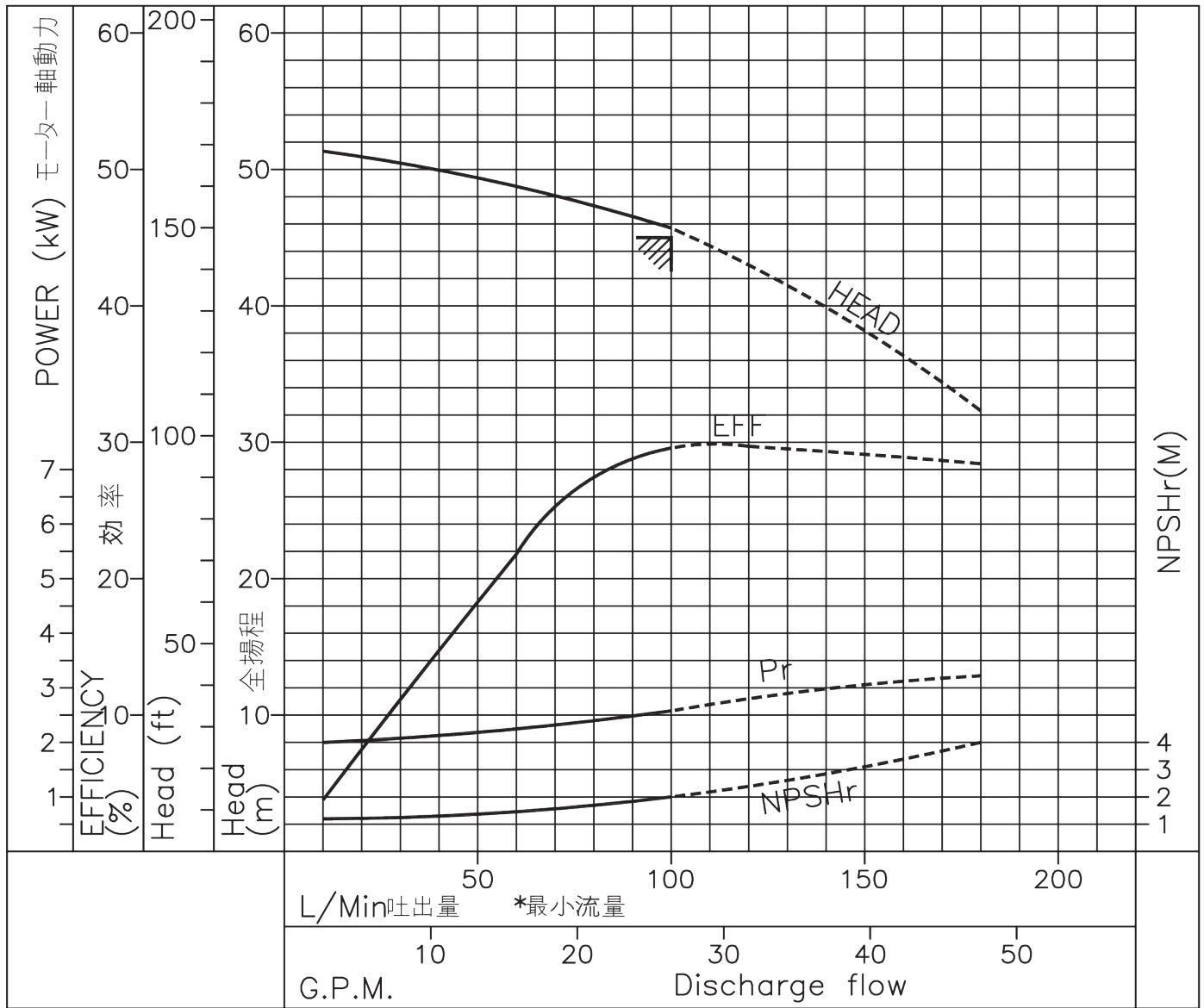

IMPELLER SIZE  
136mm  
S.G: 1.0



March May Ltd, Howard Road, Eaton Socon, St. Neots, Cambridgeshire, PE19 8NZ, UK

Tel: +44 (0) 1480 214444 Fax: +44 (0) 1480 405336 E-mail: sales@marchmay.co.uk Website: www.marchmay.co.uk